

Diritti riservati

All rights reserved

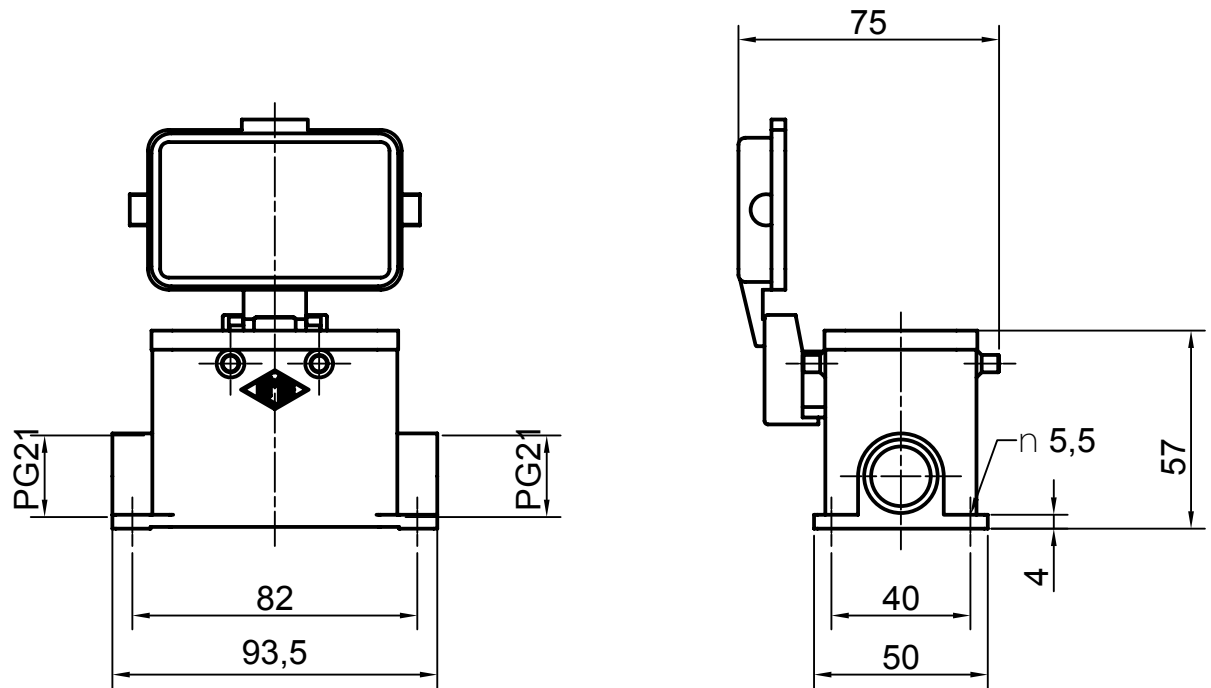

Date 04.01.2007	CMP 03 CP2		Scale
Sign.	surface mount.h.pegs, cov.2xPG16 ins.		1:2
			